

TOOTMINE.

VIKING-12 WOODEN WINDOW  
CROSS SECTION OF SILL

JOONISE NR:  
C2.1000.01

Viking Window AS  
Mäo, Järvamaa 72751 tlf.372 38 48 900

KUUPÄEV: 26.04.04 VJ.

MÕÖT: 1:1

REVISION A: 15.12.08 AAP.

REVISION B:

KINNITATUD:

REVISION C:

VJ.

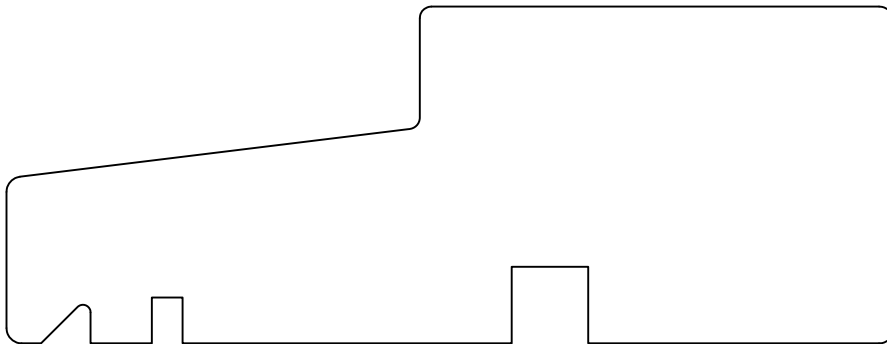
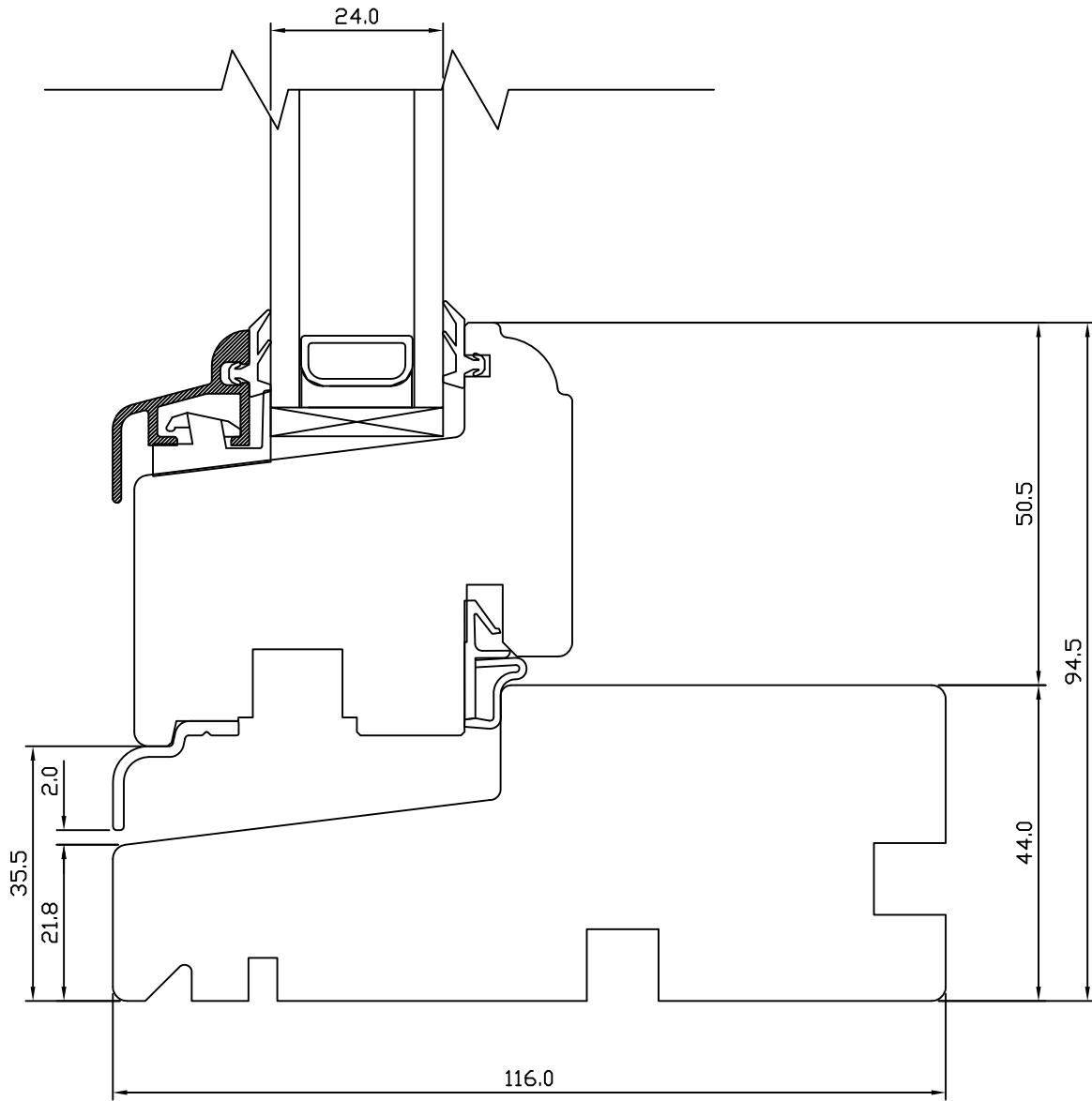

TOOTMINE.

VIKING-12 WOODEN WINDOW  
CROSS SECTION OF JAMB

JOONISE NR:  
C2.1000.02

Viking Window AS  
Mõo, Järvamaa 72751 tlf.372 38 48 900

KUUPÄEV: 26.04.04

VJ.

MÕÖT: 1:1

REVISION A: 15.12.08

AAP.

REVISION B: 25.08.11

EJ.

KINNITATUD:

REVISION C:

VJ.

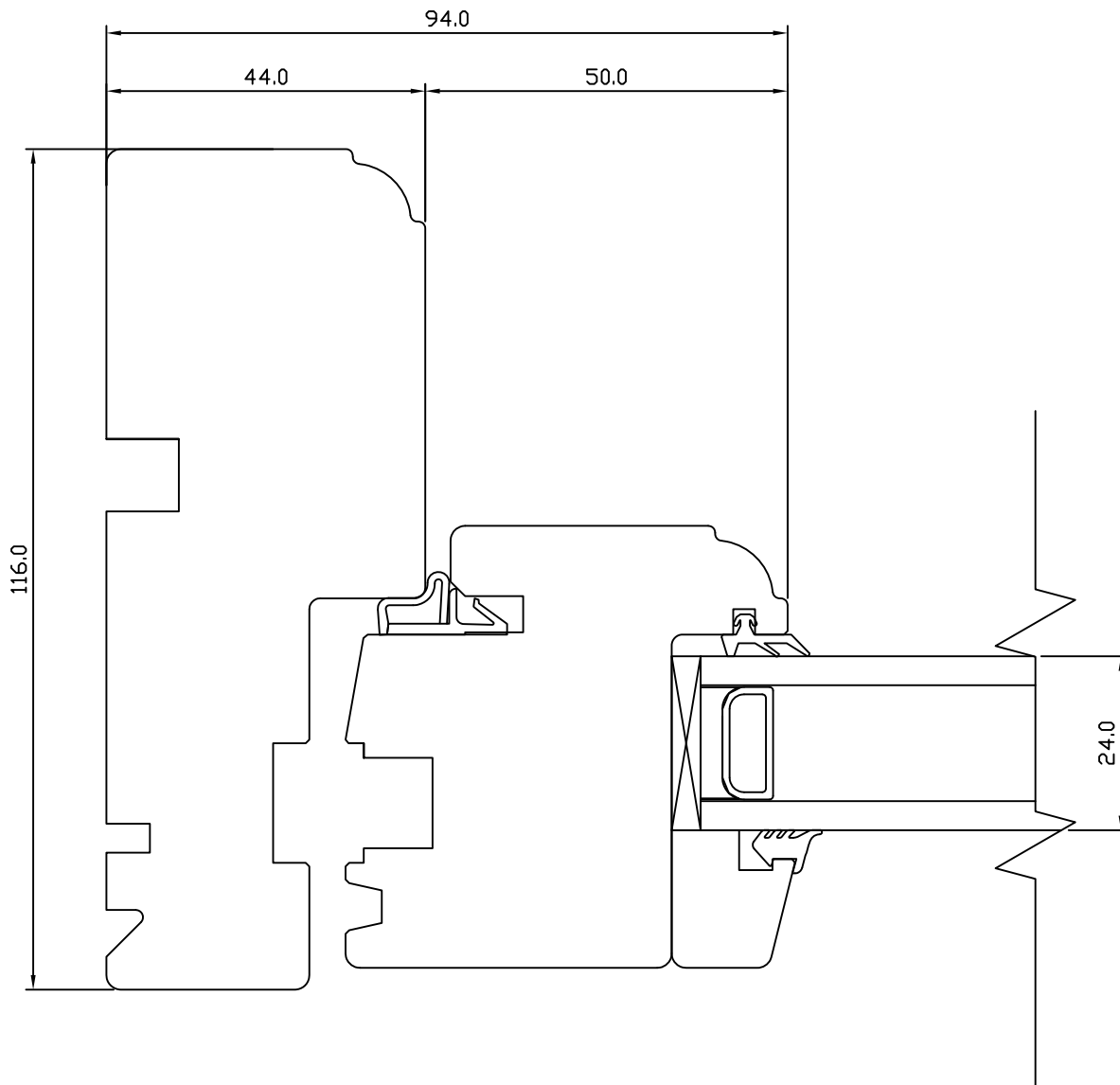

**TOOTMINE.**

Viking Window AS  
 Mäo, Järvamaa 72751 tlf.372 38 48 900

**VIKING-12 WOODEN WINDOW  
 CROSS SECTION OF HEAD**

JOONISE NR:

C2.1000.03

KUUPÄEV: 26.04.04

VJ.

MÕÖT: 1:1

REVISION A: 15.12.08

AAP.

REVISION B: 25.08.11

EJ.

KINNITATUD:

REVISION C:

VJ.

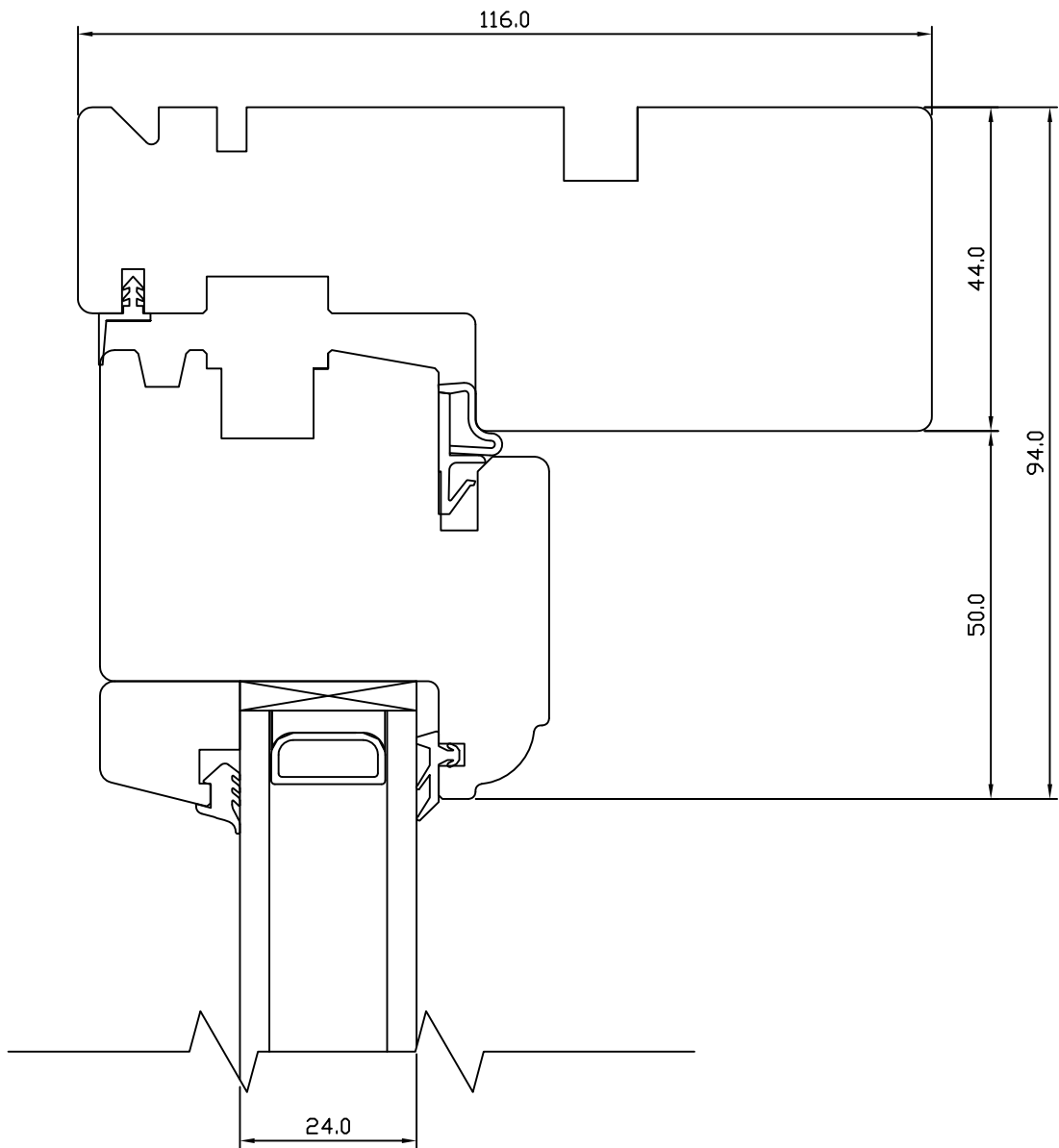

**TOOTMINE.**

Viking Window AS  
 Mäo, Järvamaa 72751 tlf.372 38 48 900

**VIKING-12 WOODEN WINDOW  
 CROSS SECTION OF TRANSOM**

JOONISE NR:  
 C2.1000.04

KUUPÄEV: 26.04.04	VJ.
REVISION A: 26.01.06	AAP.
REVISION B: 25.08.11	EJ.
REVISION C:	

MÕÖT: 1:1
KINNITATUD:
VJ.

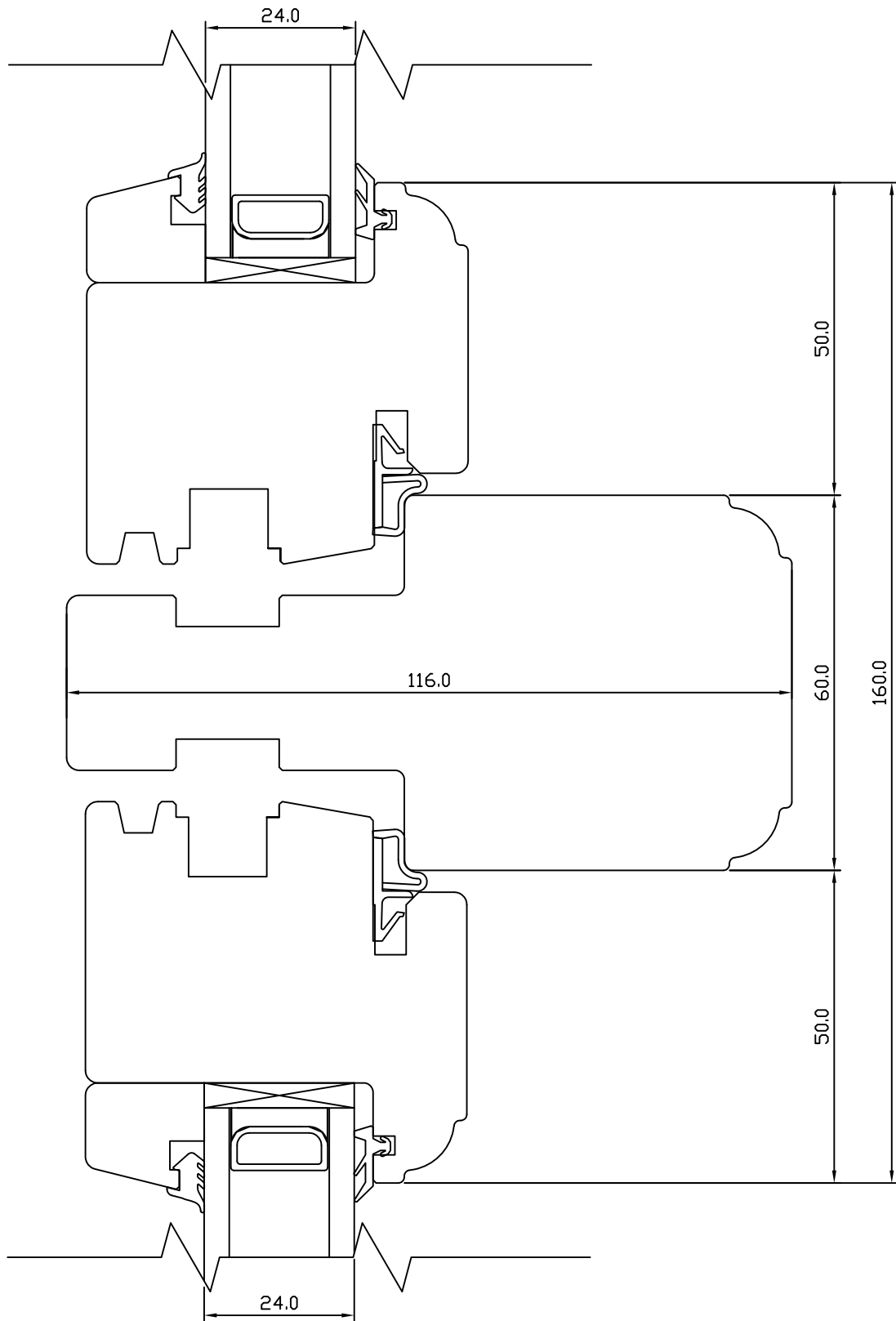

**TOOTMINE.**

Viking Window AS  
 Mäo, Järvamaa 72751 tlf.372 38 48 900

**VIKING-12 WOODEN WINDOW  
 CROSS SECTION OF MULLION**

JOONISE NR:  
 C2.1000.05

KUUPÄEV: 26.04.04	VJ.
REVISION A: 26.01.06	AAP.
REVISION B: 25.08.11	EJ.
REVISION C:	

MÕÖT: 1:1  
 KINNITATUD:  
 VJ.

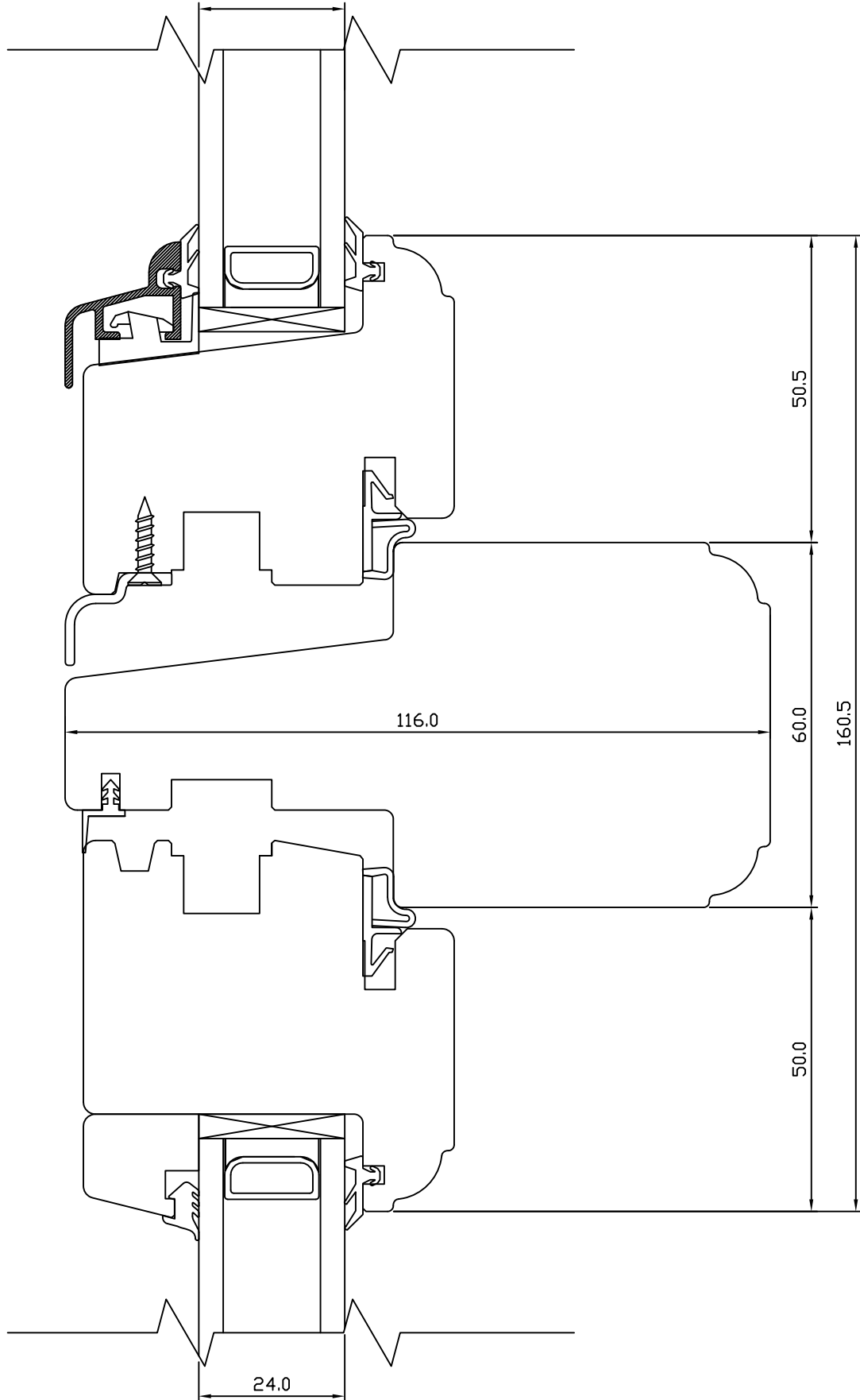

Tootja jätab endale õiguse teha muudatusi !

**TOOTMINE.**

Viking Window AS  
 Mäo, Järvamaa 72751 tlf.372 38 48 900

**VIKING-12 WOODEN WINDOW**

**CROSS SECTION OF 50mm GLAZING BARS**

JOONISE NR:

C2.1000.19

KUUPÄEV: 26.04.04

VJ.

REVISION A: 26.01.06

AAP.

REVISION B: 25.08.11

EJ.

REVISION C:

MÕÖT: 1:1

KINNITATUD:

VJ.

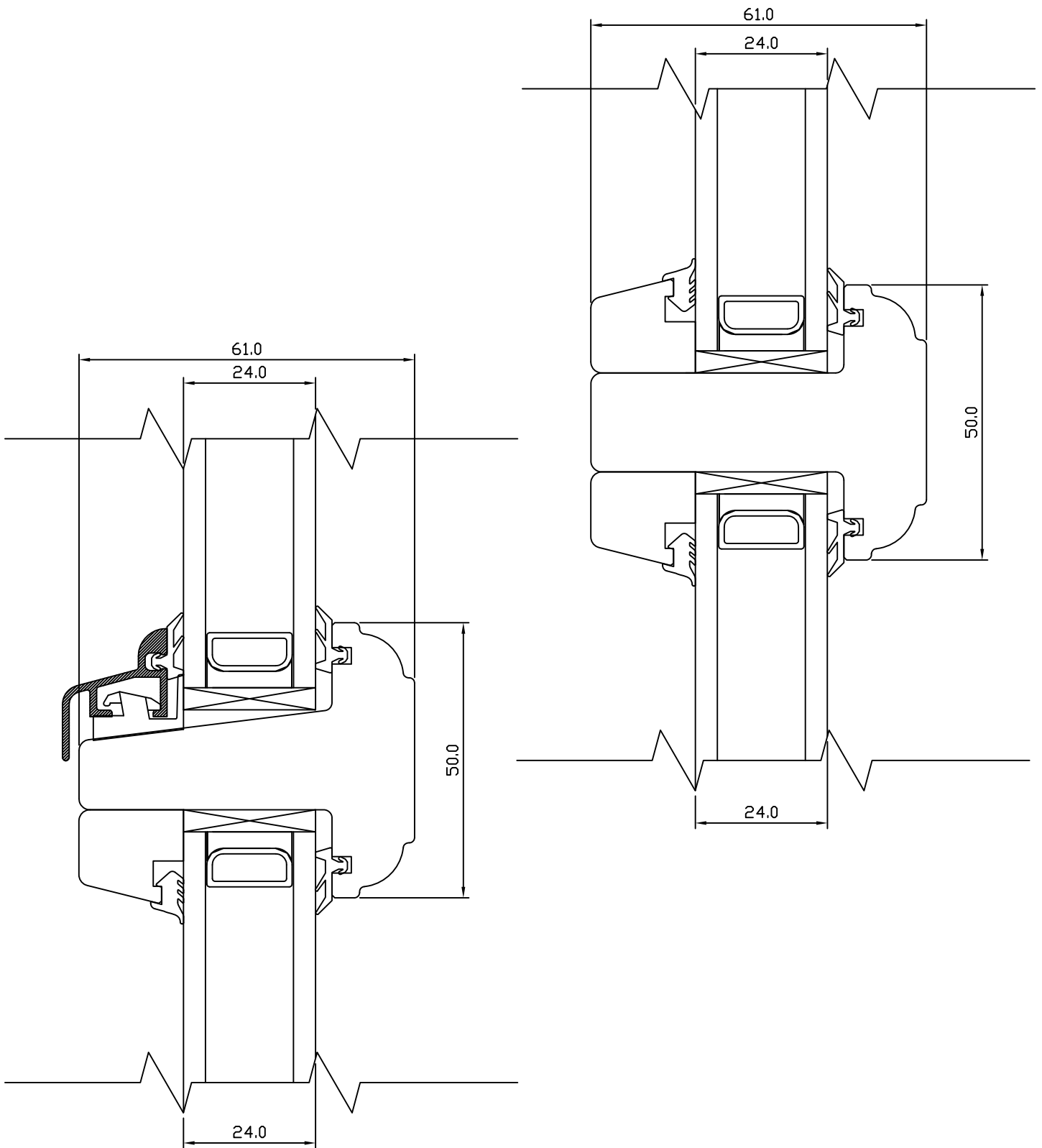

**TOOTMINE.**

Viking Window AS  
Mäo, Järvamaa 72751 tlf.372 38 48 900

**VIKING-12 WOODEN WINDOW  
CROSS SECTION OF REBATED DOUBLE  
CASEMENT**

JOONISE NR:  
C2.1000.21

KUUPÄEV: 26.04.04

VJ.

MÕÖT: 1:1

REVISION A: 26.01.06

AAP.

REVISION B: 25.08.11

EJ.

KINNITATUD:

REVISION C:

VJ.

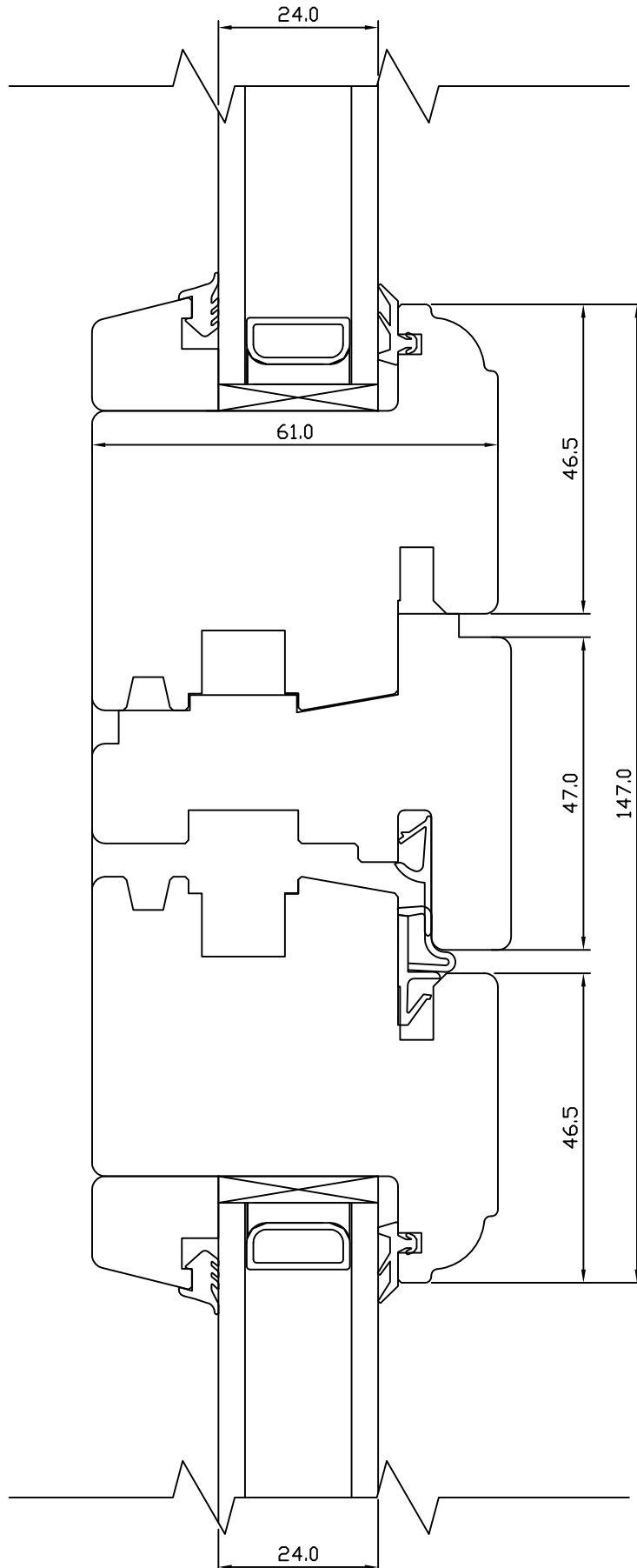

Tootja jätab endale õiguse teha muudatusi !