

TOOTMINE.

VIKING-12 ALUCLAD WINDOW
CROSS SECTION OF SILL

JOONISE NR:
NA9.1000.02

Viking Window AS
Mäo, Järvamaa 72751 tlf.372 38 48 900

KUUPÄEV: 10.12.08 AAP.

MÖÖT: 1:1

REVISION A:

REVISION B:

REVISION C:

KINNITATUD:

VJ.

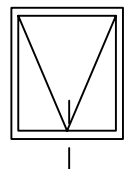
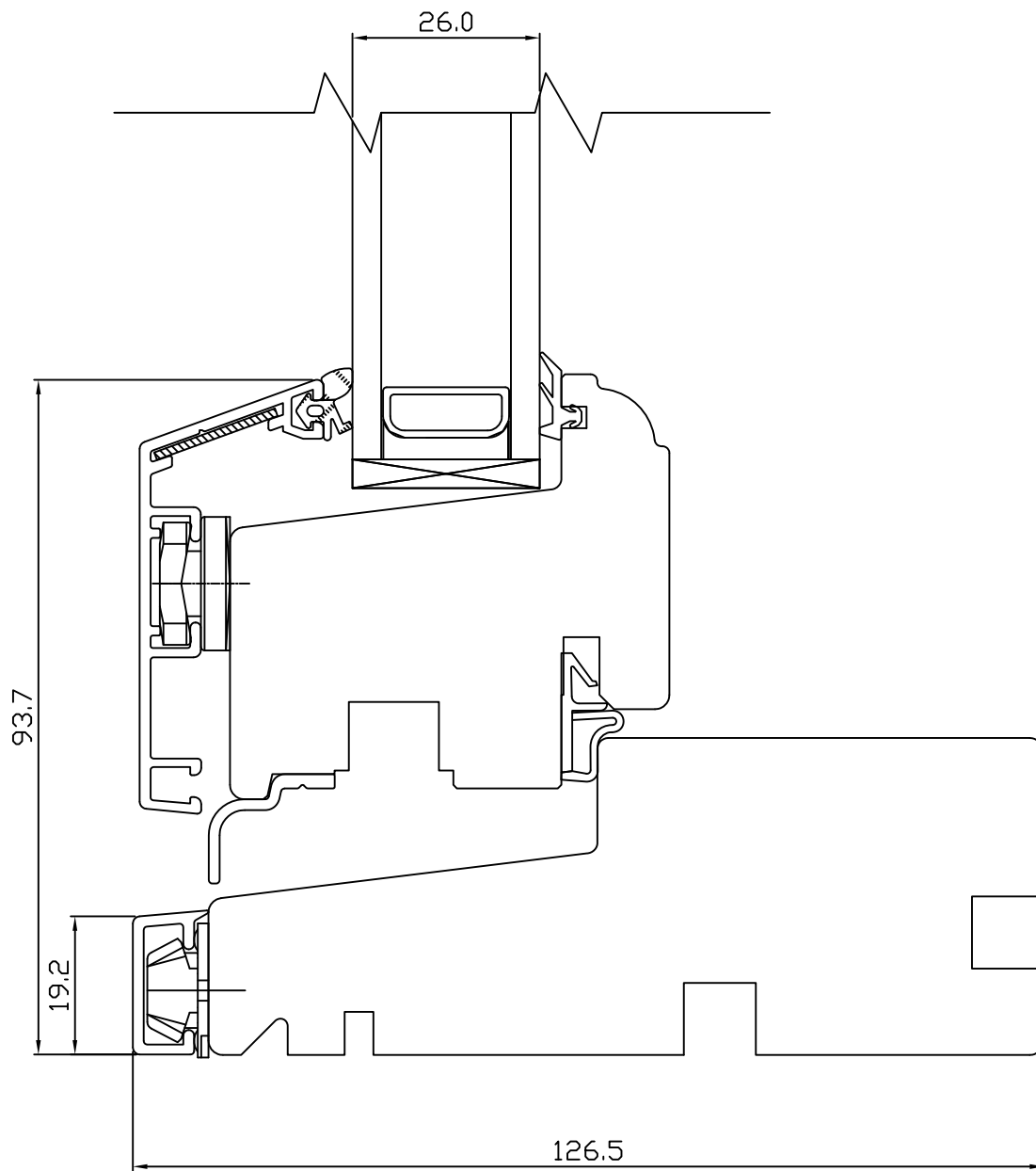

Tootja jätab endale õiguse teha muudatusi !

TOOTMINE.

Viking Window AS
 Mäo, Järvamaa 72751 tlf.372 38 48 900

**VIKING-12 ALUCLAD WINDOW
 CROSS SECTION OF JAMB**

JOONISE NR:
 NA9.1000.08

KUUPÄEV: 10.12.08 AAP.

MÕÖT: 1:1

REVISION A:

REVISION B:

REVISION C:

KINNITATUD:

VJ.

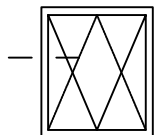
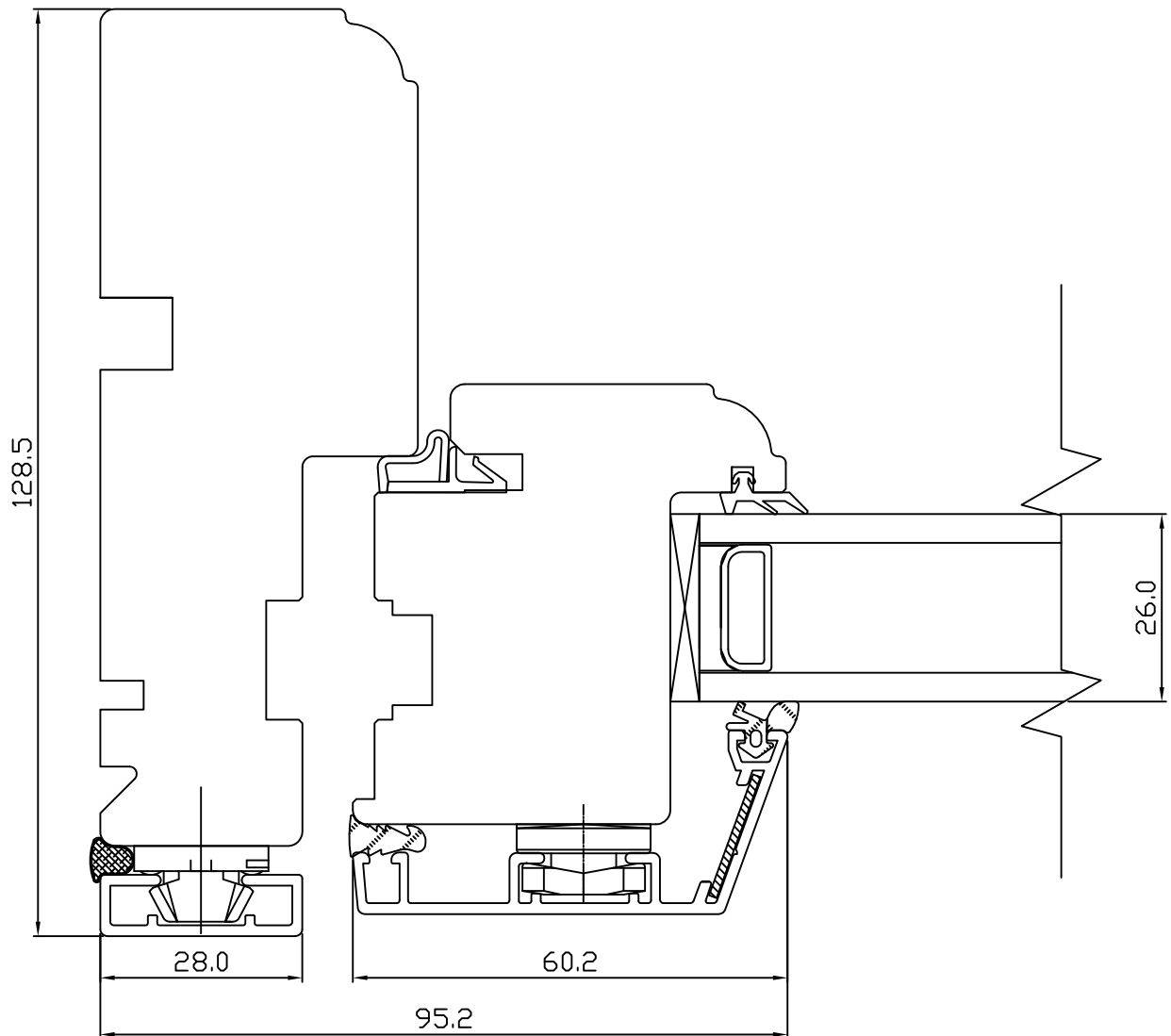

TOOTMINE.

Viking Window AS
Mäo, Järvamaa 72751 tlf.372 38 48 900

VIKING-12 ALUCLAD WINDOW
CROSS SECTION OF HEAD

JOONISE NR:
NA9.1000.01

KUUPÄEV: 10.12.08 AAP.

MÕÖT: 1:1

REVISION A:

REVISION B:

REVISION C:

KINNITATUD:

VJ.

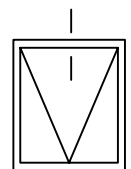
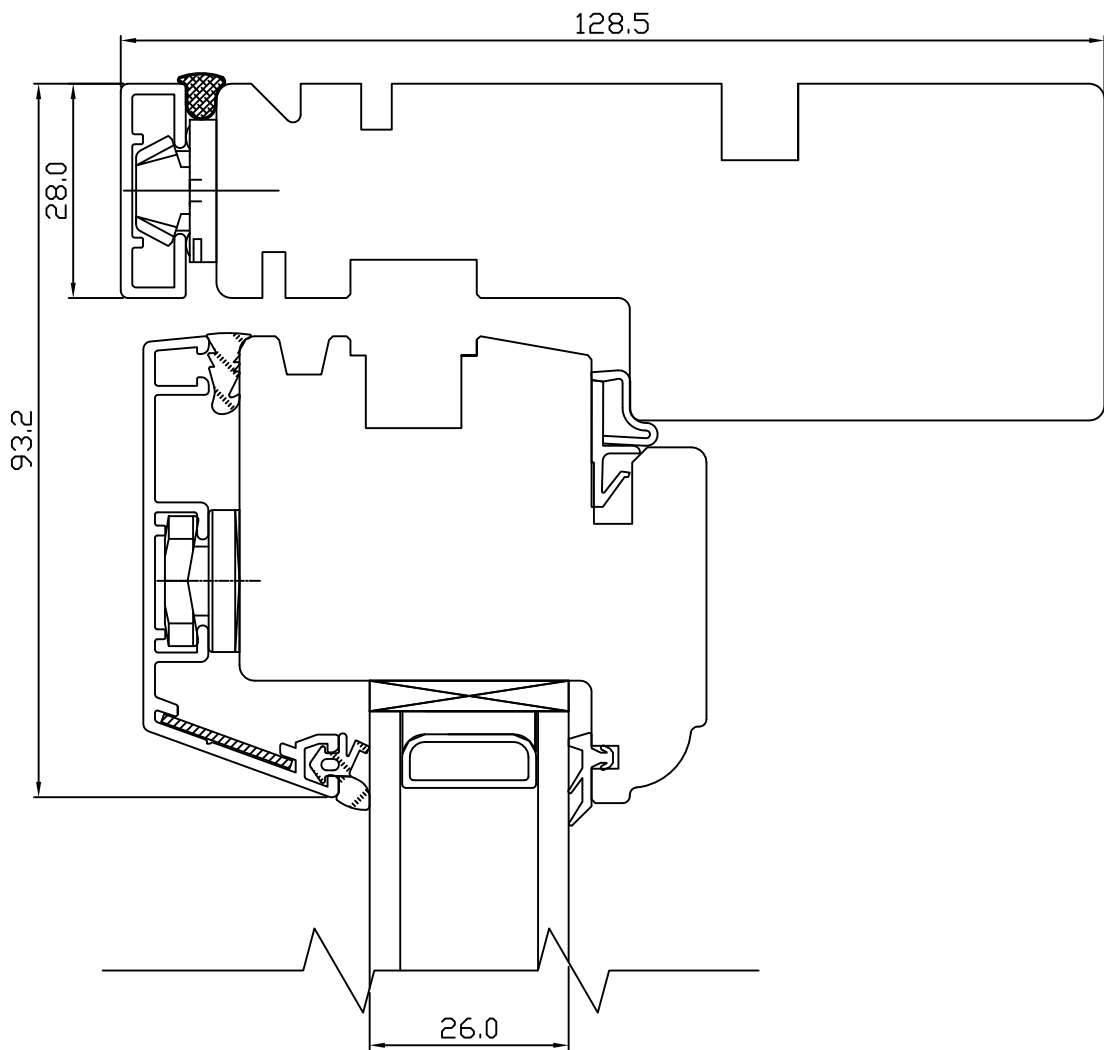

TOOTMINE.

VIKING COMBI ALUCLAD WINDOW
CROSS SECTION OF TRANSOM

JOONISE NR:

NA9.1000.03

Viking Window AS
Mäo, Järvamaa 72751 tlf.372 38 48 900

KUUPÄEV: 10.12.08 AAP.

MÕÖT: 1:1

REVISION A:

REVISION B:

REVISION C:

KINNITATUD:

VJ.

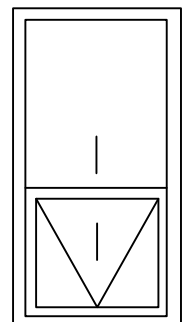
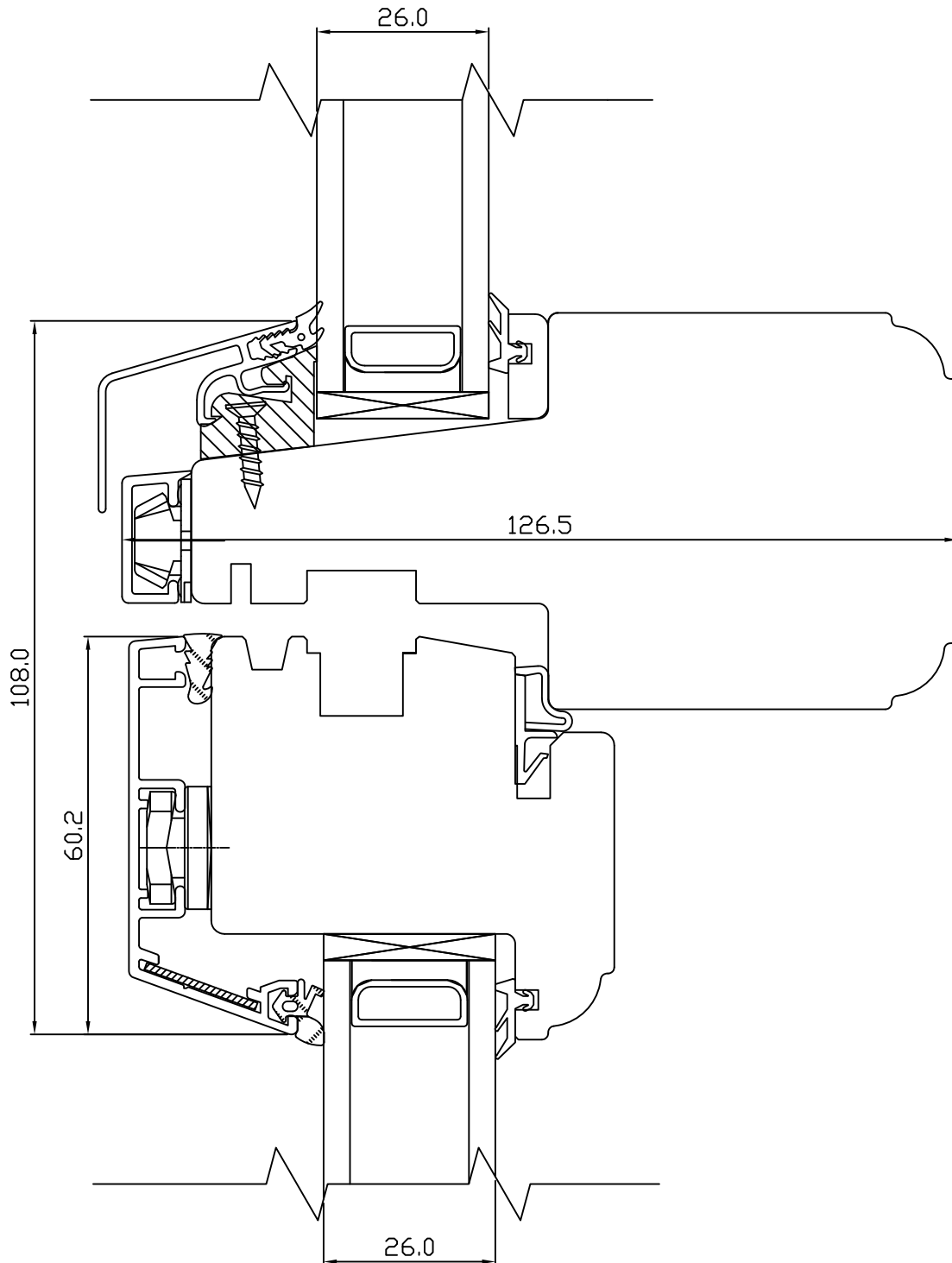

Tootja jätab endale õiguse teha muudatusi !

TOOTMINE.

VIKING-12 ALUCLAD WINDOW
CROSS SECTION OF MULLION

JOONISE NR:
NA9.1000.13

Viking Window AS
Mäo, Järvamaa 72751 tlf.372 38 48 900

KUUPÄEV: 10.12.08 AAP.

MÕÖT: 1:1

REVISION A:

REVISION B:

REVISION C:

KINNITATUD:

VJ.

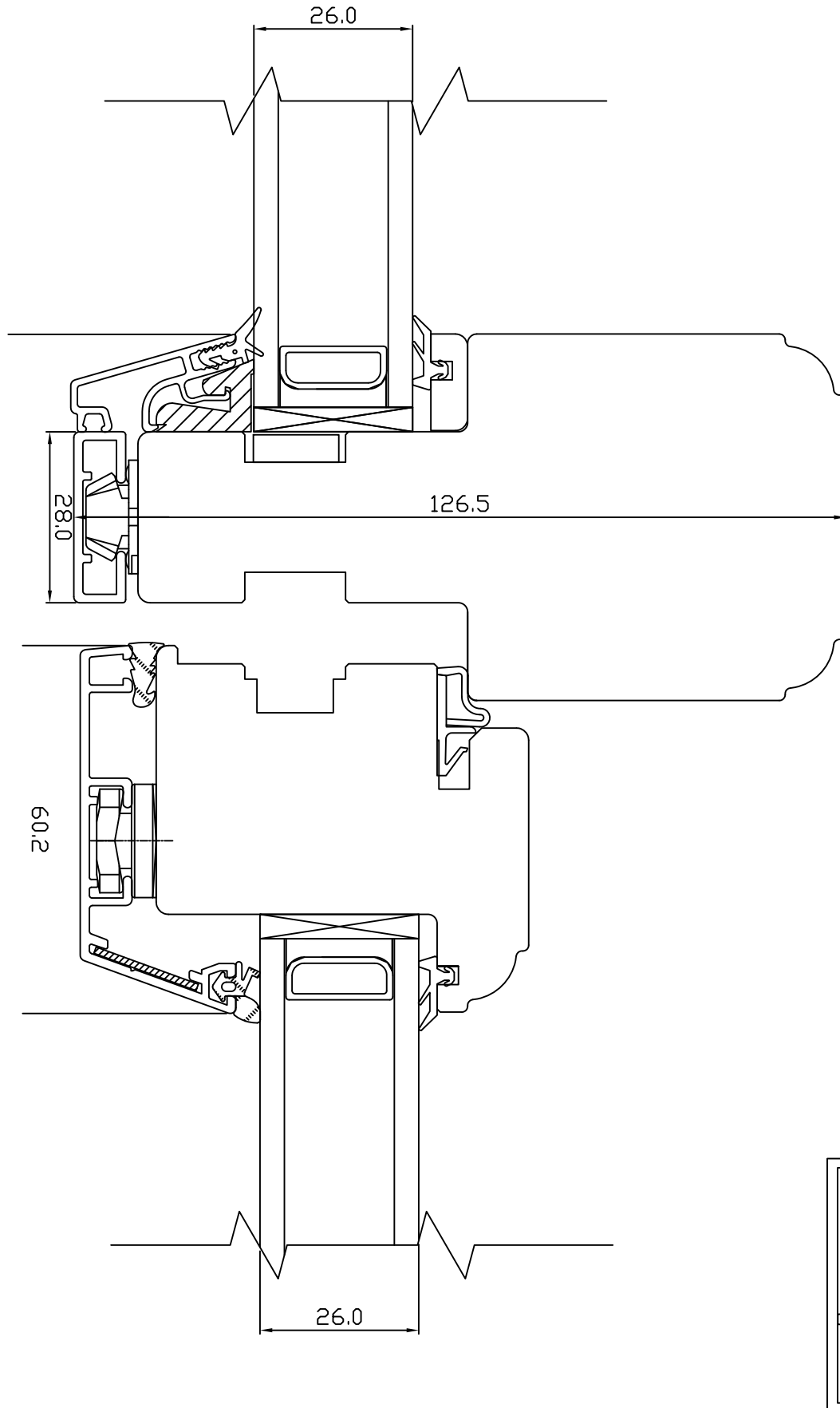

Tootja jätab endale õiguse teha muudatusi !

TOOTMINE.

Viking Window AS
Mäo, Järvamaa 72751 tlf.372 38 48 900

VIKING-12 ALUCLAD WINDOW
CROSS SECTION OF REBATED DOUBLE
CASEMENT

JOONISE NR:
NA9.1000.05

KUUPÄEV: 10.12.08 AAP.

MÕÖT: 1:1

REVISION A:

REVISION B:

REVISION C:

KINNITATUD:

VJ.

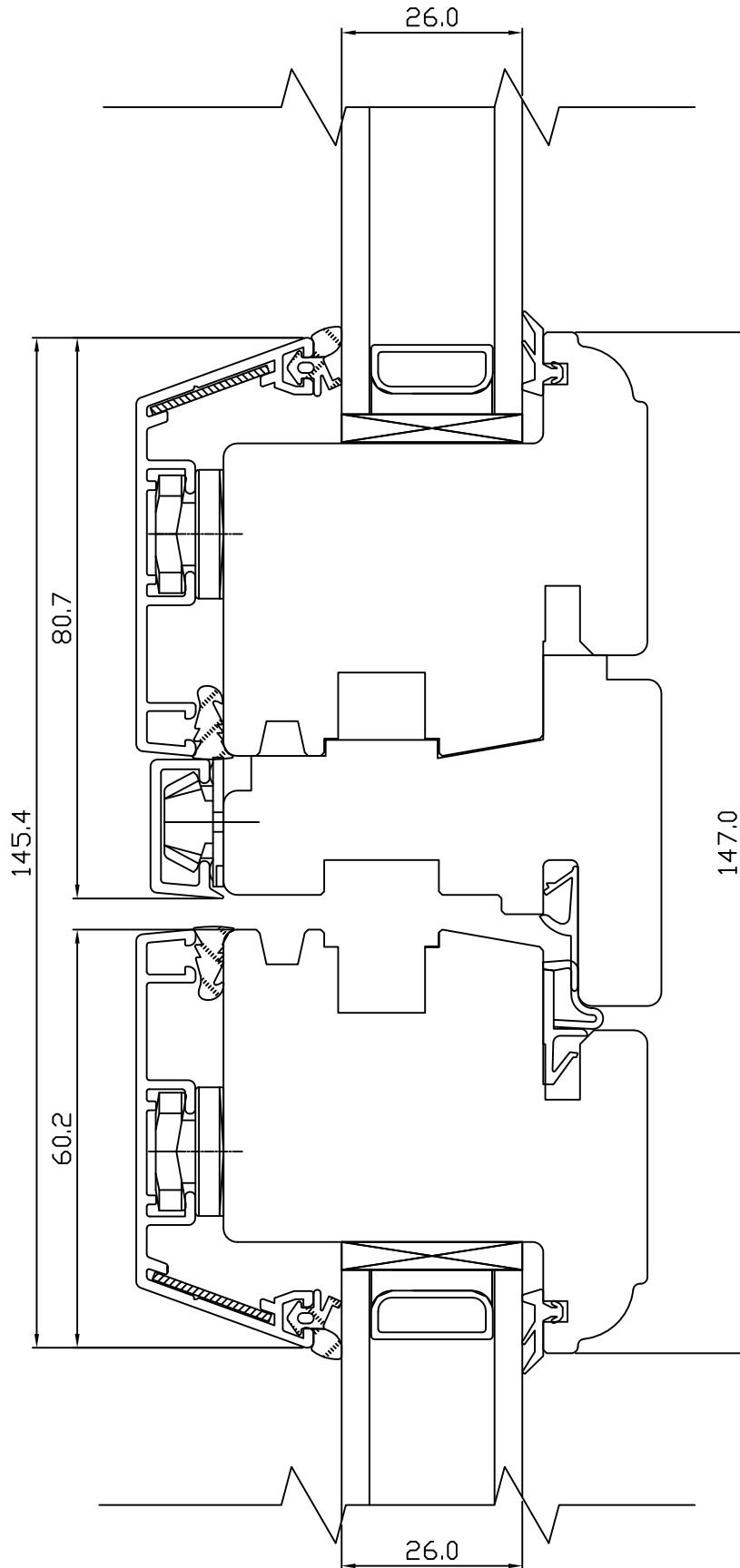

Tootja jätab endale õiguse teha muudatusi !

TOOTMINE.

VIKING-12 ALUCLAD WINDOW

JOONISE NR:

Viking Window AS
Mäo, Järvamaa 72751 tlf.372 38 48 900

CROSS SECTION OF 50 mm GLAZING BAR

NA9.1000.06

KUUPÄEV: 10.12.08 AAP.

MÕÖT: 1:1

REVISION A: 26.11.10 EJ.

REVISION B:

KINNITATUD:

REVISION C:

VJ.

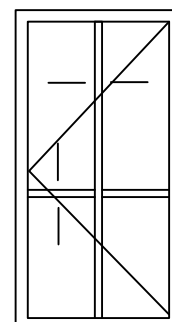
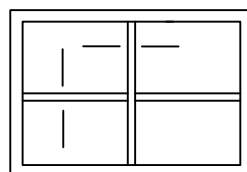
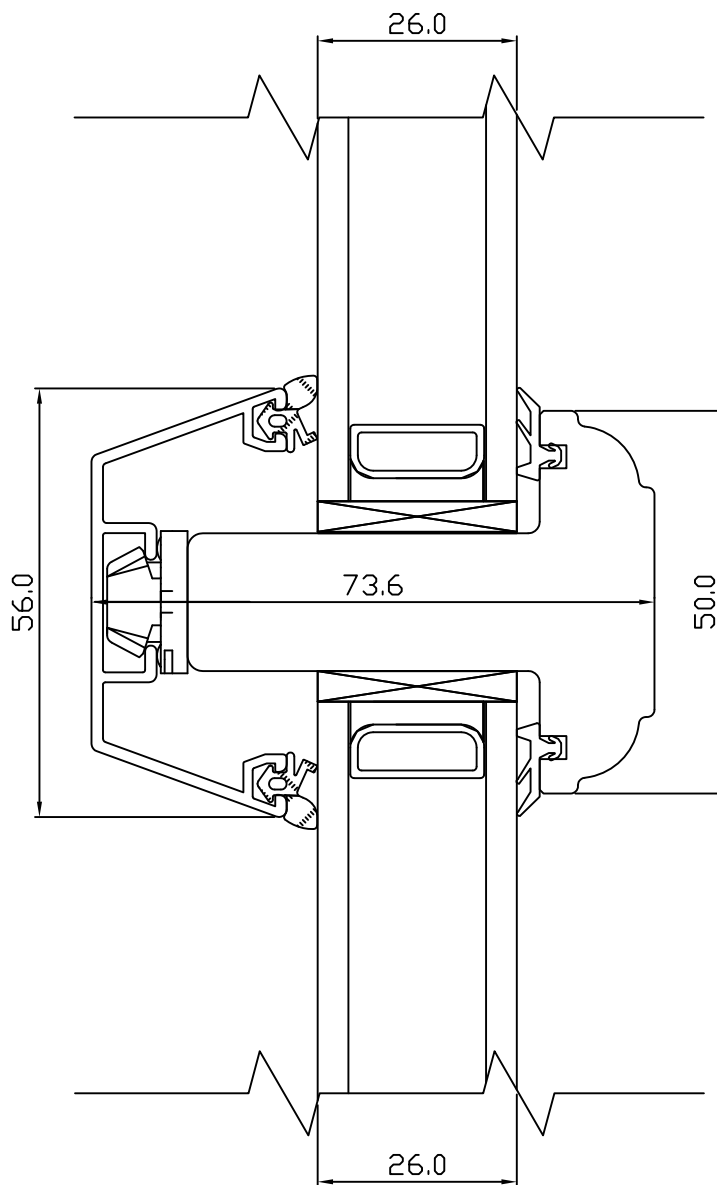

Tootja jätab endale õiguse teha muudatusi !